



Trusted above all.



Piping Products

Quick Reference Guide | EMEA





Introduction to Piping Products

Viking is renowned for the development, manufacturing, sales and distribution of excellent fire protection technologies and has been a dependable partner in fire protection for many decades.

The broad product portfolio encompasses innovative and proven system components for water, foam and gas extinguishing systems as well as fire detection systems and is a reflection of Viking's unwavering focus on providing customers with the finest products and highest level of support.

Through Viking's dedicated and knowledgeable customer service, installers of fixed fire protection systems have access to those quality products and can place their trust in the professional and dedicated support services provided by Viking employees. From the smallest project to the largest endeavour, Viking is their single-point partner with the goal to provide the right material whenever and wherever needed.

Viking is passionate about fire protection and committed to the growth of the fixed fire protection industry. As Viking is completely focused and dedicated to this market, customers can have confidence that Viking has the expertise that they need to be successful. They can count on Viking's resources and technical expertise to help them whenever they have a challenge to overcome. And they can be sure to find the right product or solution for their project with the necessary approval or accreditation.

This quick reference guide provides an overview of Viking's comprehensive range of piping products. Besides access to those products, customers benefit from a market leading technical support team across Europe and the Middle East, which also holds regular technical training courses on water, foam, gas and detection systems, products and maintenance.

Learn more at www.viking-emea.com.

Table of contents

Standard 6 m Length Welded Steel Pipes and Drop Pipes	3
Corrosion Monitoring and Testing	5
Drain and Release Valves	6
Flex Hoses	9
Welded Outlets & Drops	15
Pipe Accessories	18
Threaded Fittings	19
Tanks & Accessories	24
Pumps & Compressors	26
Pipe Hangers & Clamps	27
Seismic Attachments	32
Channels & Cantilevers	35
Nuts & Bolts	37

For all applicable approvals, please refer to the technical documentation or contact your local Viking sales office.

Standard 6m Length Welded Steel Pipes & Drop Pipes



EN 10217-1 pipes - grooved ends

DN	Part number			Dimensions (mm)	Weight (kg)
	Red	White	Galvanised		
32	842811	917752	842796	42.4 x 2.6	15.3
40	842812	917760	842797	48.3 x 2.6	17.6
50	842813	917753	842798	60.3 x 2.6	22.2
65	841626	917754	905902	76.1 x 2.6	28.3
	931352	931353	931354	76.1 x 2.9	31.4
80	841627	917755	905925	88.9 x 2.9	36.9
100	841629	917756	905927	114.3 x 3.2	52.6
125	841631	917757	905928	139.7 x 3.6	72.6
150	841632	917758	905929	168.3 x 4.0	97.2
200	842814	917759	905930	219.1 x 4.5	142.8
250	4002966	4002964	--	273.0 x 5.0	198
300	4002965	4002963	-	323.9 x 5.6	264

EN 10217-1 pipes - plain ends

DN	Part number			Dimensions (mm)	Weight (kg)
	Red	White	Galvanised		
32	-	-	842786	42.4 x 2.6	15.3
40	-	-	842787	48.3 x 2.6	17.6
50	-	-	842788	60.3 x 2.6	22.2
65	-	-	842789	76.1 x 2.6	28.3
80	-	-	842790	88.9 x 2.9	36.9
100	-	-	842791	114.3 x 3.2	52.6
125	-	-	842792	139.7 x 3.6	72.6
150	-	-	842793	168.3 x 4.0	97.2
200	-	-	842794	219.1 x 4.5	142.8

EN 10255 pipes (threadable) - grooved ends

DN	Part number			Dimensions (mm)	Weight (kg)
	Red	White	Galvanised		
25	842805	921042	842781	33.7 x 3.2	14.5
32	841623	921044	842782	42.4 x 3.2	18.5
40	841624	921046	842783	48.3 x 3.2	21.4
50	841625	921048	842784	60.3 x 3.6	30.2

EN 10255 pipes (threadable) - plain ends

DN	Part number			Dimensions (mm)	Weight (kg)
	Red	White	Galvanised		
15	-	-	103409	21.3 x 2.6	7.2
20	848805	921040	103471	26.9 x 2.6	9.4
25	848806	921041	104050	33.7 x 3.2	14.5
32	848807	921043	104098	42.4 x 3.2	18.5
40	848808	921045	104130	48.3 x 3.2	21.4
50	848809	921047	104177	60.3 x 3.6	30.2
65	-	-	920999	76.1 x 3.6	38.5
80	-	-	921001	88.9 x 4.0	50.2



Drop Pipes

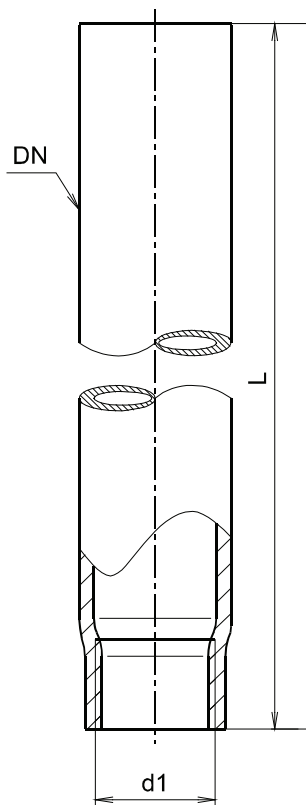
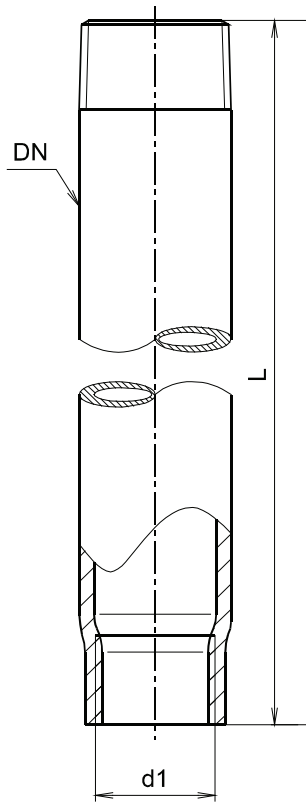

Drop pipes - EN 10255, with external thread, red				
DN	d1	L (mm)	Part Number	Weight (kg)
DN25	G1/2"	280	4006077	0.68
		380	4006078	0.93
		480	4006079	1.17
		580	4006080	1.42
		780	4006081	1.90
		980	4006082	2.39
	G3/4"	280	4006083	0.68
		380	4006084	0.93
		480	4006085	1.17
		580	4006086	1.42
		680	4006087	1.66
		780	4006088	1.90
		880	4006089	2.15
		980	4006090	2.39

Drop pipes - EN 10255, galvanized					
DN	d1	L (mm)	Part Number		Weight (kg)
			w/o external thread	with external thread	
DN20	G1/2"	180	-	779959	0.29
		280	878811	785873	0.45
		380	878823	841690	0.61
		480	878835	779960	0.77
		580	878847	785885	0.93
		680	878859	785617	1.09
		780	878860	841707	1.25
		880	878872	785629	1.41
		980	878884	785897	1.57
	1,180	-	875690	1.95	
	1,480	847931	-	2.42	
	G3/8"	280	879943	884530	0.45
		380	879955	884542	0.61
		480	879967	884554	0.77
		580	879979	884566	0.93
		680	879980	884578	1.09
		780	877399	884580	1.25
		880	877375	884591	1.41
980		877387	884608	1.57	
DN25		G1/2"	280	897656	117528
	380		897668	117530	1.00
	480		897670	117541	1.25
	580		897681	117553	1.50
	780		897693	897711	2.20
	980		897700	897723	2.45
	G3/4"	280	-	884621	0.70
		380	-	884633	0.95
		480	-	884645	1.20
		580	-	884657	1.45
		680	-	884669	1.70
		780	-	884670	1.95
		880	-	884682	2.20
		980	-	884694	2.45

Corrosion Monitoring & Testing

Corrosion monitoring	
Product	Part number
<p>PCMS-RM Corrosion monitoring station - riser mount</p>  <p>PCMS-RM consists of a coupon rack that is installed on fire sprinkler riser to monitor corrosion in a fire sprinkler system. The PCMS-RM is designed to simulate conditions within the fire sprinkler system. The coupon rack can be isolated from the fire sprinkler riser and easily accessed for servicing and monitoring of test specimens (corrosion coupons) without interruption to fire protection. Test material strip specimens (corrosion coupons) are installed into the coupon rack using coupon holders.</p>	PCMS-RM
<p>Monitoring probe kit</p>  <p>Connects to the PCMS system and provides remote notification when a certain level of corrosion occurs in a system.</p>	PCMPK-1
<p>Coupon replacement and test kit</p>  <p>Includes replacement coupons for the PCMS.</p>	CRTK
<p>Coupon & probe replacement and test kit</p>  <p>Includes replacement coupons and probes for the PCMS/PCMPK.</p>	CPRTK
Corrosion testing	
Product	Part number
<p>MIC¹ Test Kit</p>  <p>"Do-it-yourself" test kit that tests for:</p> <ul style="list-style-type: none"> - Iron related bacterium (iron-pipe oxidizing and reducing bacterium) - Sulfate reducing bacterium (causes pit corrosion) - Acid producing bacterium (causes pit corrosion) 	BAC-PAK

1 MIC = Microbiologically influenced corrosion



Drain & Release Valves

Drain valves - Monitored slow-closing valve | UL/FM

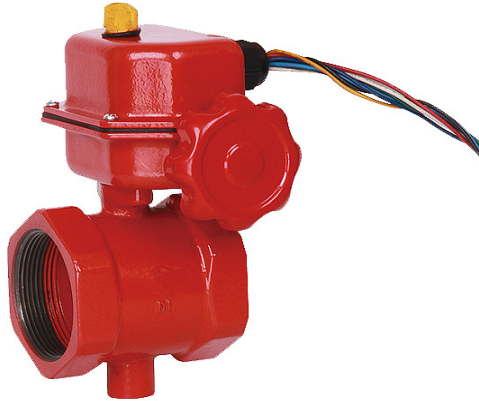

Approvals	UL, FM
Max. working pressure	12 bar (175 psi)
Material (Body)	Ductile iron
Sizes	1" (DN25) - 2" (DN50)
Connection	Threaded (NPT & BSP)
Features	Includes supervisory switch

Part number	Size	Thread type
BVT-1-025	1"/DN25	NPT
BVT-1-032	1-1/4"/DN32	NPT
BVT-1-040	1-1/2"/DN40	NPT
BVT-1-050	2"/DN50	NPT
BVT-2-025	1"/DN25	BSP
BVT-2-032	1-1/4"/DN32	BSP
BVT-2-040	1-1/2"/DN40	BSP
BVT-2-050	2"/DN50	BSP

Drain valves - Globe valve | Straight through | UL

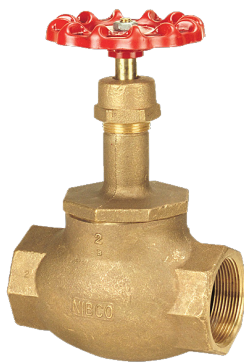

Approvals	UL
Max. working pressure	12 bar (175 psi)
Material (Body)	Cast bronze
Sizes	1-1/4" (DN32) - 2" (DN50)
Connection	Threaded
Style	Straight through

Part number	Size	Connection	Thread type
KT211WUL125	1-1/4"/DN32	Threaded	NPT
KT211WUL150	1-1/2"/DN40		
KT211WUL200	2"/DN50		

Drain valves - Globe valve | Angle | UL





Approvals	UL
Max. working pressure	12 bar (175 psi)
Sizes	1-1/4" (DN32) - 2" (DN50)
Material (Body)	Cast bronze
Connection	Threaded
Style	Angle

Part number	Size	Connection	Thread type
T301W125	1-1/4"/DN32	Threaded	NPT
T301W150	1-1/2"/DN40		
T301W200	2"/DN50		

Drain & Release Valves

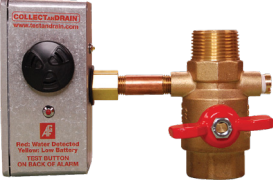
Drain valves

Product	Part number
<p data-bbox="491 427 938 454">Model 5100ALBV water detection alarm 1" NPT</p>  <p data-bbox="448 472 1270 584">The 5100ALBV is a water detection alarm that can be added to dry system auxiliary drains. When condensation collects in the auxiliary drain the model 5100ALBV gives an audible and visual notification to alert personnel that maintenance is required so the drain valve doesn't freeze and break.</p> <p data-bbox="448 600 1270 770">The 5100ALBV self-monitors ambient room temperature to determine if the system is at risk. When temperatures are safely above freezing, such as during the warm summer months, the internal monitor will put the alarm into a sleep mode and override alarm activation; even if condensation is present. This prevents the unnecessary labor of emptying collectors during the warmer months and it increases battery life due to reduced power consumption when the alarm is in sleep mode.</p> <p data-bbox="448 786 1238 842">The model 5100ALBV can be powered by a 9-volt battery, low voltage hard wire, or 110 V plug-in option.</p>	5100ALBV
<p data-bbox="491 860 938 887">Model 5150ALBV water detection alarm 1" NPT</p>  <p data-bbox="448 1032 1238 1088">The 5150ALBV is a reversible tee which allows the user to choose how much water will be collected before the alarm activates - either 30 ml/1 oz or 60 ml/2 oz.</p>	5150ALBV

Air release valves

Product	Part number
<p data-bbox="619 1364 810 1391">PAV Air release vent</p>  <ul data-bbox="448 1480 1278 1630" style="list-style-type: none"> - Displaces corrosive trapped air from within the sprinkler piping by eliminating the air-water interface (the typical location of wet pipe corrosion) - 12 bar (175 psi) - UL/FM approved - 1/2"/DN15 threaded connection 	1119720









Drain & Release Valves

COLLECTanDRAIN® auxiliary drains / Condensate traps

Dry fire sprinkler system auxiliary drains can cost thousands of euros every time they fail. COLLECTanDRAIN® auxiliary drain upgrades provide easy solutions to costly maintenance and insurance liability issues.

Auxiliary drains or condensate traps collect moisture, which can gather in dry systems and provide a method for removing the water without operating the system.

	Product	Part number
	<p>Model 5300A Basic 1" NPT</p> <ul style="list-style-type: none"> - High visibility - Galvanised collector & 1" brass valves - Meets NFPA requirements 	5300A
	<p>Model 5300ALBV Basic with water detector 1" NPT</p> <p>As 5300A plus:</p> <ul style="list-style-type: none"> - Water detector senses water in the collector and signals an audible/visual alarm locally and/or remotely 	5300ALBV
	<p>Model 5200A Basic with anti-trip</p> <p>As 5300A plus:</p> <ul style="list-style-type: none"> - Anti-trip plate prevents the opening of both valves at the same time to stop accidental system operation 	5200A
	<p>Model 5100A Basic with anti-trip</p> <p>As 5200A plus:</p> <ul style="list-style-type: none"> - Water detector senses water in the collector and signals an audible/visual alarm locally and/or remotely 	5100A
	<p>Model 5400A Basic with heated float switch & notification</p> <p>As 5300A plus:</p> <ul style="list-style-type: none"> - 5300A is installed in a heated cabinet to prevent freezing of collected condensate - Internal heating element and thermostat - Float switch activates when condensate reaches level where action is required - Audible alarm plus remote notification when float switch activates - System test feature 	5400A
	<p>Model 5400H HOT monitor</p> <p>HOT monitor option for 5400A</p> <ul style="list-style-type: none"> - Signals alarm if internal heater is not able to maintain temperature above freezing, for example if the door is left open 	5400H
	<p>Model 5400D Phone dialer</p> <p>System trouble phone dialer option for 5400A</p>	5400D
	<p>Model 5400T Anti-trip plate</p> <p>Anti-trip plate option for 5400A</p> <ul style="list-style-type: none"> - Anti-trip plate prevents the opening of both valves at the same time to stop accidental system operation 	5400T
	<p>Model 5580A All-weather cover</p> <p>All-weather cover option for 5400A</p> <ul style="list-style-type: none"> - Allows the 5400A to be installed outdoors - Additional insulation - Magnetic door seal 	5580A

Flex Hoses

S-Flex | Braided | FM Approved

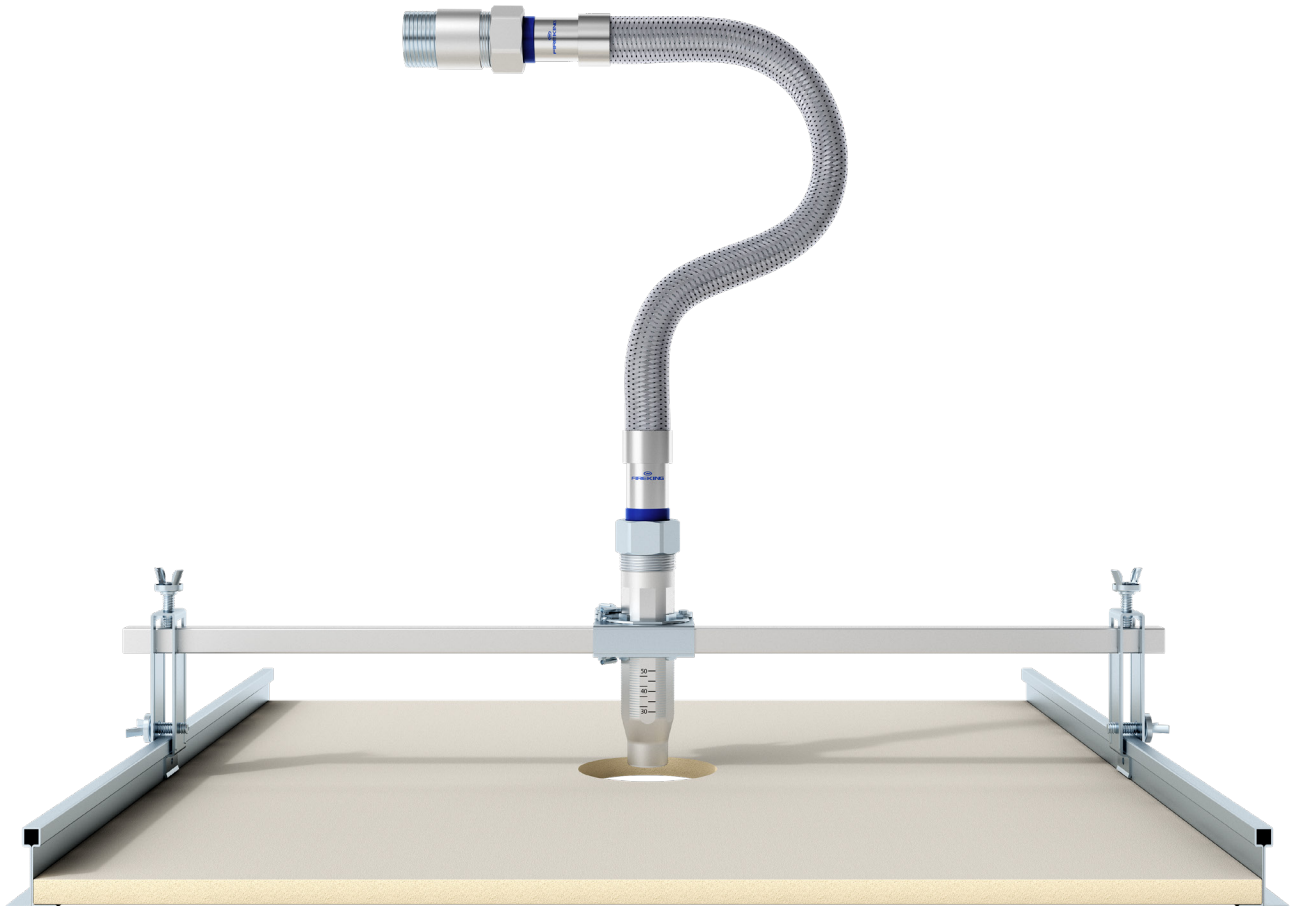

Inlet	Outlet	Length (mm)	Part number*
DN25 BSP	1/2"/15 mm	700	VK27SB-T700(1/2B)
DN25 BSP	1/2"/15 mm	1,000	VK27SB-T1000(1/2B)
DN25 BSP	1/2"/15 mm	1,200	VK27SB-T1200(1/2B)
DN25 BSP	1/2"/15 mm	1,500	VK27SB-T1500(1/2B)
DN25 BSP	1/2"/15 mm	1,800	VK27SB-T1800(1/2B)
DN25 BSP	3/4"/20 mm	700	VK27SB-T700(3/4B)
DN25 BSP	3/4"/20 mm	1,000	VK27SB-T1000(3/4B)
DN25 BSP	3/4"/20 mm	1,200	VK27SB-T1200(3/4B)
DN25 BSP	3/4"/20 mm	1,500	VK27SB-T1500(3/4B)
DN25 BSP	3/4"/20 mm	1,800	VK27SB-T1800(3/4B)
DN25 BSP	1"/25 mm	700	VK27SB-T700(1B)
DN25 BSP	1"/25 mm	1,000	VK27SB-T1000(1B)
DN25 BSP	1"/25 mm	1,200	VK27SB-T1200(1B)
DN25 BSP	1"/25 mm	1,500	VK27SB-T1500(1B)
DN25 BSP	1"/25 mm	1,800	VK27SB-T1800(1B)

*For 1" NPT Inlet version replace "1/2B" or "3/4B" with "1/2N" or "3/4N".

Inlet	Outlet	Length (mm)	Part number
DN32 BSP	1/2"/15 mm	700	VK27SB-T700(1/2K)
DN32 BSP	1/2"/15 mm	1,000	VK27SB-T1000(1/2K)
DN32 BSP	1/2"/15 mm	1,200	VK27SB-T1200(1/2K)
DN32 BSP	1/2"/15 mm	1,500	VK27SB-T1500(1/2K)
DN32 BSP	1/2"/15 mm	1,800	VK27SB-T1800(1/2K)
DN32 BSP	3/4"/20 mm	700	VK27SB-T700(3/4K)
DN32 BSP	3/4"/20 mm	1,000	VK27SB-T1000(3/4K)
DN32 BSP	3/4"/20 mm	1,200	VK27SB-T1200(3/4K)
DN32 BSP	3/4"/20 mm	1,500	VK27SB-T1500(3/4K)
DN32 BSP	3/4"/20 mm	1,800	VK27SB-T1800(3/4K)
DN32 BSP	1"/25 mm	700	VK27SB-T700(1K)
DN32 BSP	1"/25 mm	1,000	VK27SB-T1000(1K)
DN32 BSP	1"/25 mm	1,200	VK27SB-T1200(1K)
DN32 BSP	1"/25 mm	1,500	VK27SB-T1500(1K)
DN32 BSP	1"/25 mm	1,800	VK27SB-T1800(1K)



Flex Hoses

VK27B | Braided | FM, LPCB Approved & UL Listed

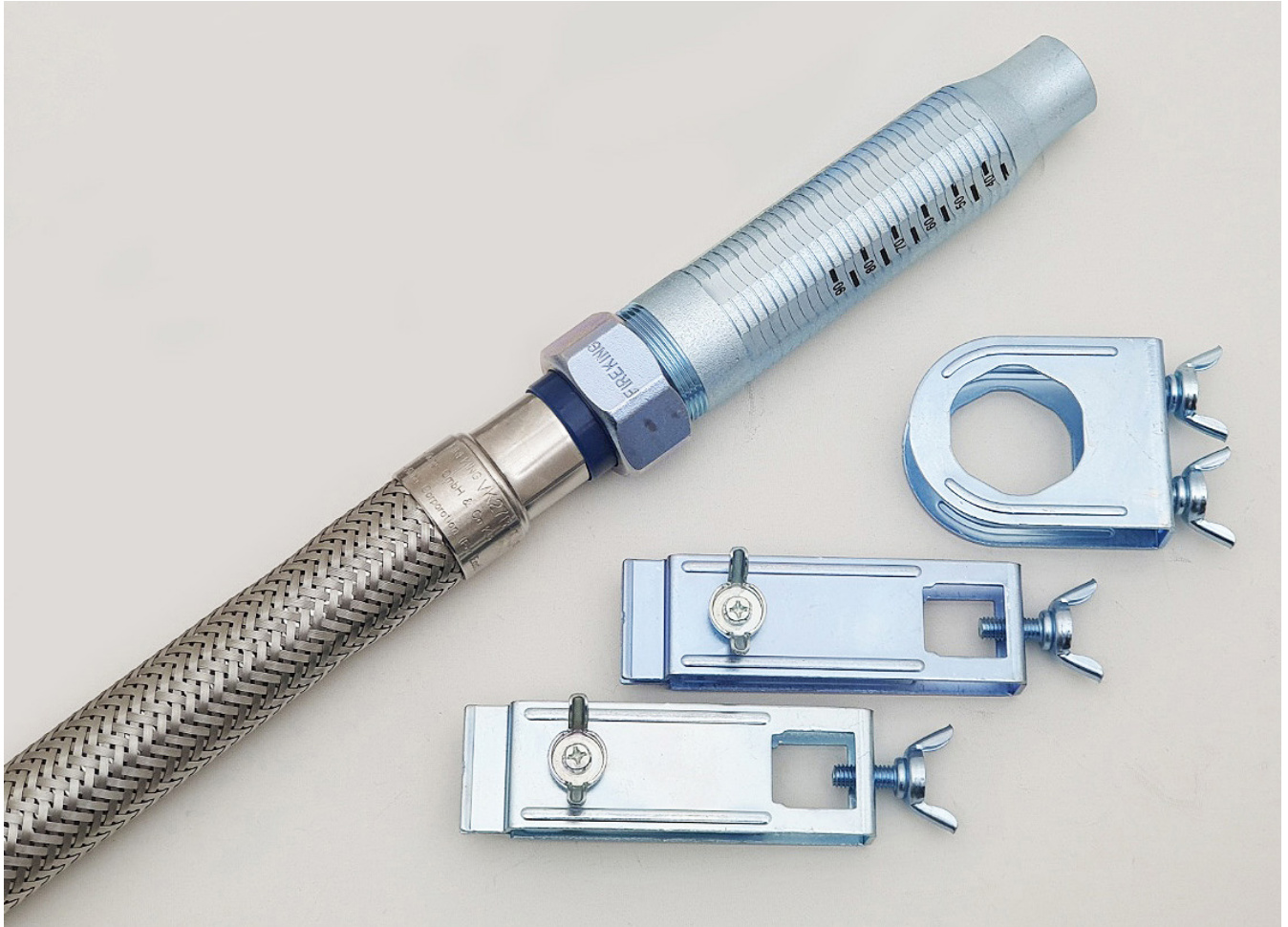

Inlet	Outlet	Length (mm)	Part number*
DN25 BSP	1/2"/15 mm	700	VK27B-T700(1/2H)
DN25 BSP	1/2"/15 mm	1,000	VK27B-T1000(1/2H)
DN25 BSP	1/2"/15 mm	1,200	VK27B-T1200(1/2H)
DN25 BSP	1/2"/15 mm	1,500	VK27B-T1500(1/2H)
DN25 BSP	1/2"/15 mm	1,800	VK27B-T1800(1/2H)
DN25 BSP	3/4"/20 mm	700	VK27B-T700(3/4H)
DN25 BSP	3/4"/20 mm	1,000	VK27B-T1000(3/4H)
DN25 BSP	3/4"/20 mm	1,200	VK27B-T1200(3/4H)
DN25 BSP	3/4"/20 mm	1,500	VK27B-T1500(3/4H)
DN25 BSP	3/4"/20 mm	1,800	VK27B-T1800(3/4H)
DN32 BSP	1/2"/15 mm	700	VK27B-T700(1/2J)
DN32 BSP	1/2"/15 mm	1,000	VK27B-T1000(1/2J)
DN32 BSP	1/2"/15 mm	1,200	VK27B-T1200(1/2J)
DN32 BSP	1/2"/15 mm	1,500	VK27B-T1500(1/2J)
DN32 BSP	1/2"/15 mm	1,800	VK27B-T1800(1/2J)
DN32 BSP	3/4"/20 mm	700	VK27B-T700(3/4J)
DN32 BSP	3/4"/20 mm	1,000	VK27B-T1000(3/4J)
DN32 BSP	3/4"/20 mm	1,200	VK27B-T1200(3/4J)
DN32 BSP	3/4"/20 mm	1,500	VK27B-T1500(3/4J)
DN32 BSP	3/4"/20 mm	1,800	VK27B-T1800(3/4J)

* For NPT version replace "1/2H" or "3/4H" with "1/2M" or "3/4M".

Flex Hoses

VK27N | Unbraided | UL Listed & LPCB Approved

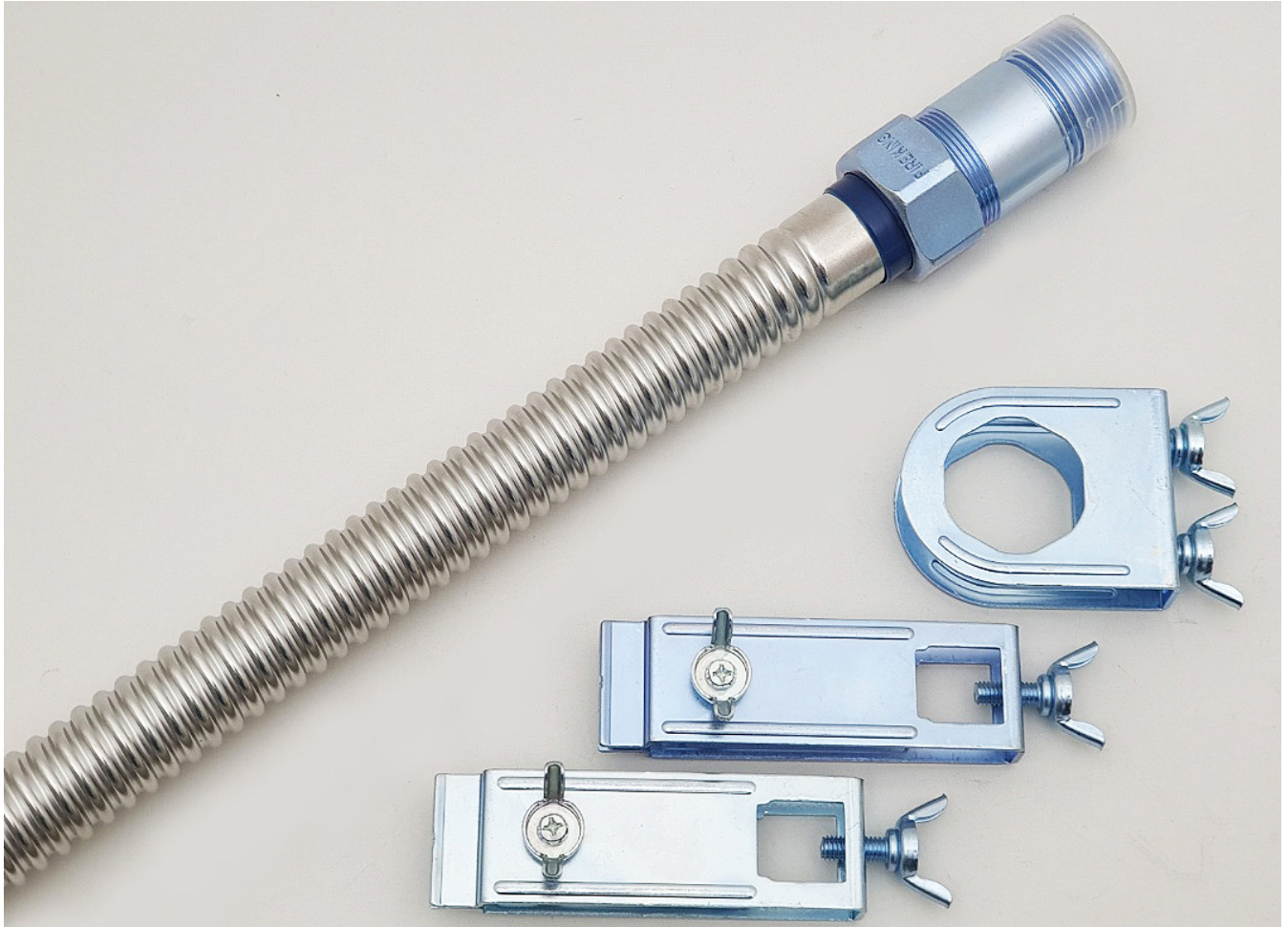

Inlet	Outlet	Length (mm)	Part number*
DN25 BSP	1/2"/15 mm	700	VK27N-T700(1/2H)
DN25 BSP	1/2"/15 mm	1,000	VK27N-T1000(1/2H)
DN25 BSP	1/2"/15 mm	1,200	VK27N-T1200(1/2H)
DN25 BSP	1/2"/15 mm	1,500	VK27N-T1500(1/2H)
DN25 BSP	1/2"/15 mm	1,800	VK27N-T1800(1/2H)
DN25 BSP	3/4"/20 mm	700	VK27N-T700(3/4H)
DN25 BSP	3/4"/20 mm	1,000	VK27N-T1000(3/4H)
DN25 BSP	3/4"/20 mm	1,200	VK27N-T1200(3/4H)
DN25 BSP	3/4"/20 mm	1,500	VK27N-T1500(3/4H)
DN25 BSP	3/4"/20 mm	1,800	VK27N-T1800(3/4H)
DN32 BSP	1/2"/15 mm	700	VK27N-T700(1/2J)
DN32 BSP	1/2"/15 mm	1,000	VK27N-T1000(1/2J)
DN32 BSP	1/2"/15 mm	1,200	VK27N-T1200(1/2J)
DN32 BSP	1/2"/15 mm	1,500	VK27N-T1500(1/2J)
DN32 BSP	1/2"/15 mm	1,800	VK27N-T1800(1/2J)
DN32 BSP	3/4"/20 mm	700	VK27N-T700(3/4J)
DN32 BSP	3/4"/20 mm	1,000	VK27N-T1000(3/4J)
DN32 BSP	3/4"/20 mm	1,200	VK27N-T1200(3/4J)
DN32 BSP	3/4"/20 mm	1,500	VK27N-T1500(3/4J)
DN32 BSP	3/4"/20 mm	1,800	VK27N-T1800(3/4J)

* For NPT version replace "1/2H" or "3/4H" with "1/2M" or "3/4M".



Flex Hoses

S-Flex, VK27B & VK27N Options & Spares				
	Product description	Type	Models	Part number
	Support bar 1,000 mm	Spare part	S-Flex VK27B VK27N	FK-VK27-SB1000
	Support bar 1,500 mm	Option		FK-VK27-SB1500
	Center bracket - clasp style	Spare part	S-Flex	FK-VK-CL2
		Option	VK27B VK27N	
	Center bracket with 2x wing bolts installed	Spare part	VK27B VK27N	FK-VK27-CB
		Option	S-Flex	
	Long side clip with 2x wing bolts	Spare part	S-Flex VK27B VK27N	FK-VK27-LC
	Plasterboard clip with 1x wing bolt	Option	S-Flex VK27B VK27N	FK-VK27-PC
	Wing bolt (1pce) 16 mm	Spare part	FK-VK27-LC FK-VK27-SC FK-VK27-PC	FK-VK27-WB
	Wing bolt (1pce) 20 mm		FK-VK27-LC	FK-VK27-WB2
	Threaded inlet nipple 1"/DN25 BSP	Spare part	S-Flex VK27B VK27N	FK-VK27-IN25B
	Threaded inlet nipple 1"/DN25 NPT			FK-VK27-IN25N
	Threaded inlet nipple 1-1/4"/DN32 BSP			FK-VK27-IN32B
	Threaded inlet nipple 1-1/4"/DN32 NPT			FK-VK27-IN32N

Note: Option indicates an optional extra to be ordered in addition to the standard flex hose, Spare Part is a part which can be ordered to replace parts already existing in the flex hose assemblies

Flex Hoses

S-Flex, VK27B & VK27N | Options & Spares



	Product description	Type	Models	Part number
	Grooved inlet nipple DN 25 (33.7 mm)	Option	S-Flex VK27B VK27N	FK-VK27-IN25G
	Grooved inlet nipple DN 32 (42.4 mm)			FK-VK27-IN32G
	Outlet Nipple straight 1/2"/DN15	Spare part	S-Flex VK27B VK27N	FK-VK27-ON15
	Outlet Nipple straight 3/4"/DN20			FK-VK27-ON20
	L-Type 90° Elbow DN15	Option	S-Flex VK27B VK27N	FK-L-15
	L-Type 90° Elbow DN20			FK-L-20
	L1 Elbow w/bracket DN15 for direct fixing to floor above false ceiling	Option	S-Flex VK27B VK27N	FK-L1-B-15
	L1 Elbow w/bracket DN20 for direct fixing to floor above false ceiling			FK-L1-B-20

Note: Option indicates an optional extra to be ordered in addition to the standard flex hose, Spare Part is a part which can be ordered to replace parts already existing in the flex hose assemblies



Flex Hoses

S-Flex, VK27B & VK27N | Options & Spares

	Product description	Type	Models	Part number
	L2 Elbow w/bracket 60mm for direct fixing to floor above false ceiling	Option	S-Flex VK27B VK27N	FK-L2-60
	L2 Elbow w/bracket 90mm for direct fixing to floor above false ceiling			FK-L2-90
	L1 Elbow DN15	Spare part	FK-L1-B-15 FK-L1-B-20	FK-L1-15
	L1 Elbow DN20			FK-L1-20
	VK Flex Hose L1 Elbow only	Spare part	FK-L1-B-15 FK-L1-B-20	FK-E25
	Short Nipple DN15 for L1 Elbow	Spare part	FK-L1-B-15 FK-L1-B-20	FK-FH-NH-15
	Short Nipple DN20 for L1 Elbow			FK-FH-NH-20

Note: Option indicates an optional extra to be ordered in addition to the standard flex hose, Spare Part is a part which can be ordered to replace parts already existing in the flex hose assemblies

Welded Outlets & Drops

Welded outlets | Threaded & grooved | UL/FM



Pipe run	Outlet (Threaded)	Part number
1-1/4" / DN32	1/2" BSP	BNO1/2X1-1/4
1-1/2" / DN40	1/2" BSP	BNO1/2X1-1/2
2" / DN50	1/2" BSP	BNO1/2X2
2-1/2" / DN65	1/2" BSP	BNO1/2X2-1/2
3" / DN80	1/2" BSP	BNO1/2X3
4" / DN100	1/2" BSP	BNO1/2X4
1-1/4" / DN32	3/4" BSP	BNO3/4X1-1/4
1-1/2" / DN40	3/4" BSP	BNO3/4X1-1/2
2" / DN50	3/4" BSP	BNO3/4X2
2-1/2" / DN65	3/4" BSP	BNO3/4X2-1/2
3" / DN80	3/4" BSP	BNO3/4X3
4" / DN100	3/4" BSP	BNO3/4X4
6" / DN150	3/4" BSP	BNO3/4X6
1-1/4" / DN32	1" BSP	BNO1X1-1/4
1-1/2" / DN40	1" BSP	BNO1X1-1/2
2" / DN50	1" BSP	BNO1X2
2-1/2" / DN65	1" BSP	BNO1X2-1/2
3" / DN80	1" BSP	BNO1X3
4" / DN100	1" BSP	BNO1X4
6" / DN150	1" BSP	BNO1X6
1-1/2" / DN40	1-1/4" BSP	BNO1-1/4X1-1/2
2" / DN50	1-1/4" BSP	BNO1-1/4X2
2-1/2" / DN65	1-1/4" BSP	BNO1-1/4X2-1/2
3" / DN80	1-1/4" BSP	BNO1-1/4X3
4" / DN100	1-1/4" BSP	BNO1-1/4X4
6" / DN150	1-1/4" BSP	BNO1-1/4X6
2" / DN50	1-1/2" BSP	BNO1-1/2X2
2-1/2" / DN65	1-1/2" BSP	BNO1-1/2X2-1/2
3" / DN80	1-1/2" BSP	BNO1-1/2X3
4" / DN100	1-1/2" BSP	BNO1-1/2X4
6" / DN150	1-1/2" BSP	BNO1-1/2X6
2-1/2" / DN65	2" BSP	BNO2X2-1/2
3" / DN80	2" BSP	BNO2X3
4" / DN100	2" BSP	BNO2X4
6" / DN150	2" BSP	BNO2X6
8" / DN200	2" BSP	BNO2X8
3" / DN80	2-1/2" BSP	BNO2-1/2X3
4" / DN100	2-1/2" BSP	BNO2-1/2X4
6" / DN150	2-1/2" BSP	BNO2-1/2X6
8" / DN200	2-1/2" BSP	BNO2-1/2X8

Pipe run	Outlet (Grooved)	Part number
2" / DN50	42.2	BNOG1-1/4X2
2-1/2" / DN65	42.2	BNOG1-1/4X2-1/2
3" / DN80	42.2	BNOG1-1/4X3
4" / DN100	42.2	BNOG1-1/4X4
6" / DN150	42.2	BNOG1-1/4X6
1-1/2" / DN40	48.3	BNOG1-1/2X1-1/2
2" / DN50	48.3	BNOG1-1/2X2
2-1/2" / DN65	48.3	BNOG1-1/2X2-1/2
3" / DN80	48.3	BNOG1-1/2X3
4" / DN100	48.3	BNOG1-1/2X4
5" / DN125	48.3	BNOG1-1/2X5
6" / DN150	48.3	BNOG1-1/2X6
8" / DN200	48.3	BNOG1-1/2X8
2" / DN50	60.3	BNOG2X2
2-1/2" / DN65	60.3	BNOG2X2-1/2
3" / DN80	60.3	BNOG2X3
4" / DN100	60.3	BNOG2X4
6" / DN150	60.3	BNOG2X6
8" / DN200	60.3	BNOG2X8
2-1/2" / DN65	76.1	BNOG2-1/2X2-1/2
3" / DN80	76.1	BNOG2-1/2X3
4" / DN100	76.1	BNOG2-1/2X4
6" / DN150	76.1	BNOG2-1/2X6
8" / DN200	76.1	BNOG2-1/2X8
3" / DN80	88.9	BNOG3X3
4" / DN100	88.9	BNOG3X4
5" / DN125	88.9	BNOG3X5
6" / DN100	88.9	BNOG3X6
8" / DN200	88.9	BNOG3X8
4" / DN100	114.3	BNOG4X4
6" / DN150	114.3	BNOG4X6
8" / DN200	114.3	BNOG4X8
6" / DN150	165.1	BNOGY6X6
8" / DN200	165.1	BNOGY6X8
6" / DN150	168.3	BNOG6X6
8" / DN200	168.3	BNOG6X8



Welded Outlets & Drops

Drop nipples | Adjustable | UL/FM



Inlet	Outlet	Length (mm)	Part number
1" / DN25 BSP Female	1/2"/15 mm	93-119	V912011005
1" / DN25 BSP Female	1/2"/15 mm	119-170	V912021005
1" / DN25 BSP Female	1/2"/15 mm	144-220	V912031005
1" / DN25 BSP Male	1/2"/15 mm	119-144	V91201M1005
1" / DN25 BSP Male	1/2"/15 mm	144-195	V91202M1005
1" / DN25 BSP Male	1/2"/15 mm	170-246	V91203M1005

Drop nipples | Model VS | Adjustable | VdS



Inlet	Outlet	Length (mm)	Part number
1" / DN25 BSP Male	1/2"/15 mm	100-160	1291001602515
1" / DN25 BSP Male	1/2"/15 mm	140-240	1291402402515
1" / DN25 BSP Male	1/2"/15 mm	220-320	1292203202515
1" / DN25 BSP Male	1/2"/15 mm	300-400	1293004002515
1" / DN25 BSP Male	3/8"/10 mm	100-160	129012510
1" / DN25 BSP Male	3/8"/10 mm	140-240	129022510
1" / DN25 BSP Male	3/8"/10 mm	220-320	129032510
1" / DN25 BSP Male	3/8"/10 mm	300-400	129042510

Welded Outlets & Drops

Drop nipples | Double nipple | Galvanised



Thread (both ends)	Length (mm)	Part number
1/2" / DN15	40	203648
	50	681690
	60	203636
	80	911719
	100	112609
	110	772175
	115	792559
	120	213282
	140	112622
	150	112646
	160	776429
	200	116240
	220	769408
	320	112660
	450	815343
3/4" / DN20	100	824476
	120	112737
	150	112750
1" / DN25	150	751047
	400	761628
1-1/4" / DN32	60	790630
	110	170326
	150	113018
	200	113079
1-1/2" / DN40	80	113110
	100	113146
	200	848646
	425	845585
2" / DN50	530	879293
	60	113213
	80	113225
	100	113237
	175	820392



Pipe Accessories

Weld-on flange



Diameter	Part number	
	ANSI	PN16
2-1/2" / DN65	SOF0250	-
3" / DN80	SOF0300	SOF0300PN16
4" / DN100	SOF0400	SOF0400PN16
6" / DN150	SOF0600	SOF0600PN16
8" / DN200	SOF0800	SOF0800PN16
10" / DN250	SOF1000	SOF1000PN16

Flange sets | Bolts, nuts, washers & gasket



Diameter	Part number
2" / DN50	SET009050F
2-1/2" / DN65	SET009065F
3" / DN80	SET009080F
4" / DN100	SET009100F
6" / DN150	SET009150F
8" / DN200	SET009200F
10" / DN250	SET009250F
12" / DN300	SET009300F
14" / DN350	SET009350F
16" / DN400	SET009400F

Flange sets | Bolts, nuts, washers

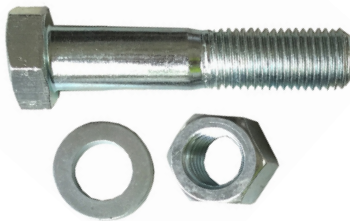

Diameter	Part number
2" - 2-1/2" / DN50 - DN65	SET009050065J
3" - 4" / DN80 - DN100	SET009100J
6" / DN150	SET009150J
8" / DN200	SET009200J
10" / DN250	SET009250J
12" / DN300	SET009500J

Flange sets | Gasket



Diameter	Part number
2-1/2" / DN65	G0250
3" / DN80	G0030
4" / DN100	G0040
6" / DN150	G0060
8" / DN200	G0080
10" / DN250	G0100
12" / DN300	G0120

Threaded Fittings

Pipe nipple



Connection ¹	Finish	Size	Part number
M/M	Unfinished	DN20	V1241645
M/M	Unfinished	DN25	V1241652
M/M	Unfinished	DN32	V1241660
M/M	Unfinished	DN40	V1241678
M/M	Unfinished	DN50	V1241686
M/M	Galvanised	DN20	V1241793
M/M	Galvanised	DN25	V1241801
M/M	Galvanised	DN32	V1241819
M/M	Galvanised	DN40	V1241827
M/M	Galvanised	DN50	V1241835

Coupling



Connection ¹	Finish	Size	Part number
F/F	Unfinished	DN25	V1246057
F/F	Unfinished	DN32	V1246065
F/F	Unfinished	DN40	V1246073
F/F	Unfinished	DN50	V1246081
F/F	Galvanised	DN25	V1246206
F/F	Galvanised	DN32	V1246214
F/F	Galvanised	DN40	V1246222
F/F	Galvanised	DN50	V1246230
F/M	Unfinished	DN25	V1260959
F/M	Unfinished	DN32	V1260967
F/M	Unfinished	DN40	V1260975
F/M	Unfinished	DN50	V1260983
F/M	Galvanised	DN25	V1261106
F/M	Galvanised	DN32	V1261114
F/M	Galvanised	DN40	V1261122
F/M	Galvanised	DN50	V1261130

Elbow 90°



Connection ¹	Finish	Size	Part number
F/F	Unfinished	DN25	V1270057
F/F	Unfinished	DN32	V1270065
F/F	Unfinished	DN40	V1270073
F/F	Unfinished	DN50	V1270081
F/F	Galvanised	DN25	V1270206
F/F	Galvanised	DN32	V1270214
F/F	Galvanised	DN40	V1270222
F/F	Galvanised	DN50	V1270230
F/F	Unfinished	DN25 x 15	V1270438
F/F	Unfinished	DN25 x 20	V1270446
F/F	Unfinished	DN32 x 15	V1270479
F/F	Unfinished	DN32 x 20	V1270487
F/F	Unfinished	DN32 x 25	V1270495
F/F	Galvanised	DN25 x 15	V1270933
F/F	Galvanised	DN25 x 20	V1270941
F/F	Galvanised	DN32 x 15	V1270975
F/F	Galvanised	DN32 x 20	V1270982
F/F	Galvanised	DN32 x 25	V1270990
M/F	Unfinished	DN25	V1271352
M/F	Unfinished	DN32	V1271360
M/F	Unfinished	DN40	V1271378
M/F	Unfinished	DN50	V1271386
M/F	Galvanised	DN25	V1271501
M/F	Galvanised	DN32	V1271519
M/F	Galvanised	DN40	V1271527
M/F	Galvanised	DN50	V1271535

¹ M = Male, F = Female



Threaded Fittings

Equal Tee



Connection ¹	Finish	Size	Part number
F/F/F	Unfinished	DN15	V1276039
F/F/F	Unfinished	DN20	V1276047
F/F/F	Unfinished	DN25	V1276054
F/F/F	Unfinished	DN32	V1276062
F/F/F	Unfinished	DN40	V1276070
F/F/F	Unfinished	DN50	V1276088
F/F/F	Galvanised	DN15	V1276187
F/F/F	Galvanised	DN20	V1276195
F/F/F	Galvanised	DN25	V1276203
F/F/F	Galvanised	DN32	V1276211
F/F/F	Galvanised	DN40	V1276229
F/F/F	Galvanised	DN50	V1276237

Reducing Tee

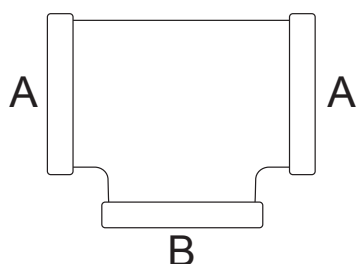

Connection ¹	Finish	Size A x B	Part number
F/F/F	Unfinished	DN25 x 15	V1276609
F/F/F	Unfinished	DN25 x 20	V1276617
F/F/F	Unfinished	DN25 x 32	V1276625
F/F/F	Unfinished	DN25 x 40	V1276633
F/F/F	Unfinished	DN32 x 15	V1276690
F/F/F	Unfinished	DN32 x 20	V1276708
F/F/F	Unfinished	DN32 x 25	V1276716
F/F/F	Unfinished	DN32 x 40	V1276724
F/F/F	Unfinished	DN32 x 50	V1276732
F/F/F	Unfinished	DN40 x 15	V1276781
F/F/F	Unfinished	DN40 x 20	V1276799
F/F/F	Unfinished	DN40 x 25	V1276807
F/F/F	Unfinished	DN40 x 32	V1276815
F/F/F	Unfinished	DN40 x 50	V1276823
F/F/F	Unfinished	DN50 x 15	V1276880
F/F/F	Unfinished	DN50 x 20	V1276898
F/F/F	Unfinished	DN50 x 25	V1276906
F/F/F	Unfinished	DN50 x 32	V1276914
F/F/F	Unfinished	DN50 x 40	V1276922
F/F/F	Galvanised	DN25 x 15	V1277904
F/F/F	Galvanised	DN25 x 20	V1277912
F/F/F	Galvanised	DN25 x 32	V1277920
F/F/F	Galvanised	DN25 x 40	V1277938
F/F/F	Galvanised	DN32 x 15	V1277995
F/F/F	Galvanised	DN32 x 20	V1278001
F/F/F	Galvanised	DN32 x 25	V1278019
F/F/F	Galvanised	DN32 x 40	V1278027
F/F/F	Galvanised	DN32 x 50	V1278035
F/F/F	Galvanised	DN40 x 15	V1278084
F/F/F	Galvanised	DN40 x 20	V1278092
F/F/F	Galvanised	DN40 x 25	V1278100
F/F/F	Galvanised	DN40 x 32	V1278118
F/F/F	Galvanised	DN40 x 50	V1278126
F/F/F	Galvanised	DN50 x 15	V1278183
F/F/F	Galvanised	DN50 x 20	V1278191
F/F/F	Galvanised	DN50 x 25	V1278209
F/F/F	Galvanised	DN50 x 32	V1278217
F/F/F	Galvanised	DN50 x 40	V1278225

¹ M = Male, F = Female

Threaded Fittings

Reducing Tee



Connection ¹	Finish	Size A x B x C	Part number
F/F/F	Unfinished	DN25 x 25 x 15	V1280411
F/F/F	Unfinished	DN25 x 10 x 20	V1280460
F/F/F	Unfinished	DN25 x 15 x 20	V1280478
F/F/F	Unfinished	DN25 x 20 x 20	V1280486
F/F/F	Unfinished	DN25 x 25 x 20	V1280494
F/F/F	Unfinished	DN32 x 32 x 15	V1280668
F/F/F	Unfinished	DN32 x 25 x 20	V1280734
F/F/F	Unfinished	DN32 x 32 x 20	V1280742
F/F/F	Unfinished	DN32 x 15 x 25	V1280817
F/F/F	Unfinished	DN32 x 20 x 25	V1280825
F/F/F	Unfinished	DN32 x 25 x 25	V1280833
F/F/F	Unfinished	DN32 x 32 x 25	V1280841
F/F/F	Unfinished	DN40 x 32 x 20	V1280952
F/F/F	Unfinished	DN40 x 25 x 25	V1281146
F/F/F	Unfinished	DN40 x 32 x 25	V1281153
F/F/F	Unfinished	DN40 x 40 x 25	V1281161
F/F/F	Unfinished	DN40 x 15 x 32	V1281211
F/F/F	Unfinished	DN40 x 20 x 32	V1281229
F/F/F	Unfinished	DN40 x 25 x 32	V1281237
F/F/F	Unfinished	DN40 x 32 x 32	V1281245
F/F/F	Unfinished	DN40 x 40 x 32	V1281252
F/F/F	Unfinished	DN50 x 50 x 15	V1281393
F/F/F	Unfinished	DN50 x 50 x 25	V1281567
F/F/F	Unfinished	DN50 x 25 x 40	V1281724
F/F/F	Galvanised	DN25 x 25 x 15	V1283217
F/F/F	Galvanised	DN25 x 10 x 20	V1283266
F/F/F	Galvanised	DN25 x 15 x 20	V1283274
F/F/F	Galvanised	DN25 x 20 x 20	V1283282
F/F/F	Galvanised	DN25 x 25 x 20	V1283290
F/F/F	Galvanised	DN32 x 32 x 15	V1283464
F/F/F	Galvanised	DN32 x 25 x 20	V1283530
F/F/F	Galvanised	DN32 x 32 x 20	V1283548
F/F/F	Galvanised	DN32 x 15 x 25	V1283613
F/F/F	Galvanised	DN32 x 20 x 25	V1283621
F/F/F	Galvanised	DN32 x 25 x 25	V1283639
F/F/F	Galvanised	DN32 x 32 x 25	V1283647
F/F/F	Galvanised	DN32 x 40 x 25	V1283654
F/F/F	Galvanised	DN40 x 40 x 20	V1283878
F/F/F	Galvanised	DN40 x 25 x 25	V1283944
F/F/F	Galvanised	DN40 x 32 x 25	V1283951
F/F/F	Galvanised	DN40 x 40 x 25	V1283969
F/F/F	Galvanised	DN40 x 15 x 32	V1284017
F/F/F	Galvanised	DN40 x 20 x 32	V1284025
F/F/F	Galvanised	DN40 x 25 x 32	V1284033
F/F/F	Galvanised	DN40 x 32 x 32	V1284041
F/F/F	Galvanised	DN40 x 40 x 32	V1284058

¹ M = Male, F = Female



Threaded Fittings

Reducing coupling



Connection ¹	Finish	Size	Part number
F/M	Unfinished	DN25 x 15	V1313337
F/M	Unfinished	DN25 x 20	V1313345
F/M	Unfinished	DN32 x 15	V1313386
F/M	Unfinished	DN32 x 20	V1313394
F/M	Unfinished	DN32 x 25	V1313402
F/M	Unfinished	DN40 x 15	V1313436
F/M	Unfinished	DN40 x 20	V1313444
F/M	Unfinished	DN40 x 25	V1313451
F/M	Unfinished	DN40 x 32	V1313469
F/M	Unfinished	DN50 x 15	V1313493
F/M	Unfinished	DN50 x 20	V1313501
F/M	Unfinished	DN50 x 25	V1313519
F/M	Unfinished	DN50 x 32	V1313527
F/M	Unfinished	DN50 x 40	V1313535
F/M	Galvanised	DN25 x 15	V1314137
F/M	Galvanised	DN25 x 20	V1314145
F/M	Galvanised	DN32 x 15	V1314186
F/M	Galvanised	DN32 x 20	V1314194
F/M	Galvanised	DN32 x 25	V1314202
F/M	Galvanised	DN40 x 15	V1314236
F/M	Galvanised	DN40 x 20	V1314244
F/M	Galvanised	DN40 x 25	V1314251
F/M	Galvanised	DN40 x 32	V1314269
F/M	Galvanised	DN50 x 15	V1314293
F/M	Galvanised	DN50 x 20	V1314301
F/M	Galvanised	DN50 x 25	V1314319
F/M	Galvanised	DN50 x 32	V1314327
F/M	Galvanised	DN50 x 40	V1314335

Hex pipe nipple



Connection ¹	Finish	Size	Part number
M/M	Unfinished	DN25	V1316355
M/M	Unfinished	DN32	V1316363
M/M	Unfinished	DN40	V1316371
M/M	Unfinished	DN50	V1316389
M/M	Galvanised	DN25	V1316504
M/M	Galvanised	DN32	V1316512
M/M	Galvanised	DN40	V1316520
M/M	Galvanised	DN50	V1316538
M/M	Unfinished	DN25 x 15	V1316934
M/M	Unfinished	DN25 x 20	V1316942
M/M	Galvanised	DN32 x 25	V1317700

¹ M = Male, F = Female

Threaded Fittings

Bushing



Connection ¹	Finish	Size	Part number
M/F	Unfinished	DN25 x 15	V1318336
M/F	Unfinished	DN25 x 20	V1318344
M/F	Unfinished	DN32 x 15	V1318385
M/F	Unfinished	DN32 x 20	V1318393
M/F	Unfinished	DN32 x 25	V1318401
M/F	Unfinished	DN40 x 15	V1318443
M/F	Unfinished	DN40 x 20	V1318450
M/F	Unfinished	DN40 x 25	V1318468
M/F	Unfinished	DN40 x 32	V1318476
M/F	Unfinished	DN50 x 15	V1318518
M/F	Unfinished	DN50 x 20	V1318526
M/F	Unfinished	DN50 x 25	V1318534
M/F	Unfinished	DN50 x 32	V1318542
M/F	Unfinished	DN50 x 40	V1318559
M/F	Galvanised	DN25 x 15	V1319235
M/F	Galvanised	DN25 x 20	V1319243
M/F	Galvanised	DN32 x 15	V1319284
M/F	Galvanised	DN32 x 20	V1319292
M/F	Galvanised	DN32 x 25	V1319300
M/F	Galvanised	DN40 x 15	V1319342
M/F	Galvanised	DN40 x 20	V1319359
M/F	Galvanised	DN40 x 25	V1319367
M/F	Galvanised	DN40 x 32	V1319375
M/F	Galvanised	DN50 x 15	V1319417
M/F	Galvanised	DN50 x 20	V1319425
M/F	Galvanised	DN50 x 25	V1319433
M/F	Galvanised	DN50 x 32	V1319441
M/F	Galvanised	DN50 x 40	V1319458

Plug



Connection ¹	Finish	Size	Part number
M	Unfinished	DN20	V1320043
M	Unfinished	DN25	V1320050
M	Unfinished	DN32	V1320068
M	Unfinished	DN40	V1320076
M	Unfinished	DN50	V1320084
M	Galvanised	DN15	V1320183
M	Galvanised	DN20	V1320191
M	Galvanised	DN25	V1320209
M	Galvanised	DN32	V1320217
M	Galvanised	DN40	V1320225
M	Galvanised	DN50	V1320233

Cap



Connection ¹	Finish	Size	Part number
F	Unfinished	DN25	V1328947
F	Unfinished	DN32	V1328954
F	Unfinished	DN40	V1328962
F	Unfinished	DN50	V1328970
F	Galvanised	DN25	V1329135

Hex nipple



Connection ¹	Finish	Size	Part number
F/F	Unfinished	DN32 x 25	V1317007
F/F	Unfinished	DN40 x 32	V1317032

¹ M = Male, F = Female



Tanks & Accessories

Float valve



Valve	Size	Part number
SV1	1" / DN25	913796
SV2	2" / DN50	820768
SV2	3" / DN80	820756

Vortex inhibitor



Size (mm)	Part number
100	844471
150	844472
200	844473
250	844474
300	844475

Tanks & Accessories

Water pressure vessel

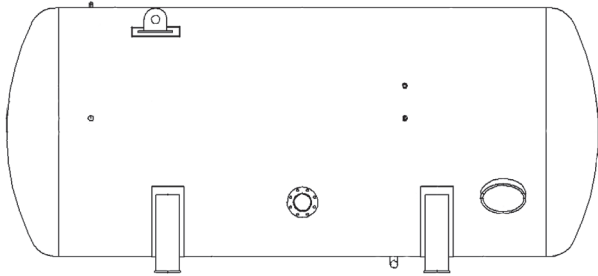

Volume (total / water) m ³	Connection	Part number
20 / 15	4" / DN100	840189
20 / 15	6" / DN150	840188
22.5 / 7.5	4" / DN100	840192
22.5 / 15	4" / DN100	840191
22.5 / 15	6" / DN150	840190
25 / 15	4" / DN100	840195
27.5 / 15	4" / DN100	840197
27.5 / 15	6" / DN150	840196
30 / 7.5	4" / DN100	840201
30 / 15	4" / DN100	840199
30 / 15	6" / DN150	840198
35 / 7.5	4" / DN100	841137
35 / 15	4" / DN100	841135
35 / 15	6" / DN150	841134
40 / 7.5	4" / DN100	841140
40 / 15	4" / DN100	841139
40 / 15	6" / DN150	841138
45 / 7.5	4" / DN100	840204
45 / 15	4" / DN100	840203
45 / 15	6" / DN150	840202

Water pressure vessel | Accessories

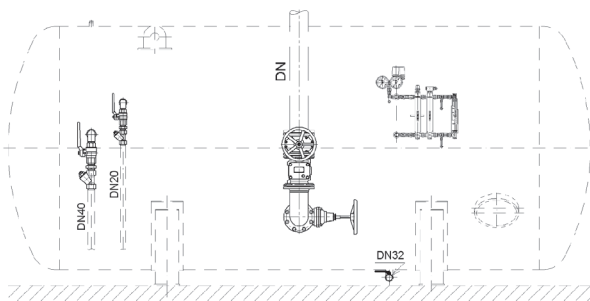

Product	Connection	Part number
Valves plus level indicator	4" / DN100	842246
Valves plus level indicator	6" / DN150	842250
Valves plus level indicator & top up	4" / DN100	842247
Valves plus level indicator & top up	6" / DN150	842251
Valves plus level indicator & monitoring	4" / DN100	842248
Valves plus level indicator & monitoring	6" / DN150	842252
Valves plus level indicator, top up & monitoring	4" / DN100	842249



Pumps & Compressors

Compressor | Riser mount | UL/FM

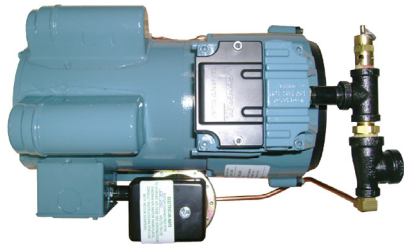

Power (hp)	Power (kW)	Voltage (V/Hz)	Part number
0.25	0.2	115 / 60	11497
0.25	0.2	220 / 50	11498
0.25	0.2	230 / 60	12629
0.25	0.2	110 / 50	12630
0.33	0.25	115 / 60	19191
0.33	0.25	230 / 50	19192
0.33	0.25	230 / 60	19193

Compressor | Riser mount



Power (hp)	Power (kW)	Voltage	Part number
0.33	0.25	240V AC	3LBD29M303X

Compressor | Tank mounted | CE



Power (hp)	Power (kW)	Voltage	Tank size (l)	Part number
2.0	1.5	210V AC	50	848213
3.0	2.2	460V AC	50	848214

Jockey pump | Pressure retaining | Automatic



Power (hp)	Power (kW)	Voltage (V/Hz)	Part number
0.75	1.1	380-415 / 50	899598
3.0	2.2	380-415 / 50	791440
5.4	4.0	400 / 50	824749
10.0	7.5	380-415 / 50	791439
14.75	11.0	380-415 / 50	815185

Pipe Hangers & Clamps

Loop hanger | Model 115N | UL/FM



Size	Finish	Pipe size	Part number
M10	Electro zinc plated	1/2" / DN15	V597860
M10	Electro zinc plated	3/4" / DN20	V597870
M10	Electro zinc plated	1" / DN25	V597880
M10	Electro zinc plated	1-1/4" / DN32	V597890
M10	Electro zinc plated	1-1/2" / DN40	V597900
M10	Electro zinc plated	2" / DN50	V597910
M10	Electro zinc plated	2-1/2" / DN65	V597920
M10	Electro zinc plated	3" / DN80	V597930
M10	Electro zinc plated	4" / DN100	V597940
M12	Electro zinc plated	5" / DN125	V597950
M12	Electro zinc plated	6" / DN150	V597960
M12	Electro zinc plated	8" / DN200	V597970

Loop hanger | Model FCS | FM/VdS



Approval	Size	Finish	Pipe size	Part number
VdS	M8	Electro zinc plated	1/2" / DN15	FCS0050M8
VdS	M8	Electro zinc plated	3/4" / DN20	FCS0075M8
VdS	M8	Electro zinc plated	1" / DN25	FCS0100M8
VdS	M8	Electro zinc plated	1-1/4" / DN32	FCS0125M8
VdS	M8	Electro zinc plated	1-1/2" / DN40	FCS0150M8
VdS	M8	Electro zinc plated	2" / DN50	FCS0200M8
FM/VdS	M10	Electro zinc plated	3/4" / DN20	FCS0075
FM/VdS	M10	Electro zinc plated	1" / DN25	FCS0100
FM/VdS	M10	Electro zinc plated	1-1/4" / DN32	FCS0125
FM/VdS	M10	Electro zinc plated	1-1/2" / DN40	FCS0150
FM/VdS	M10	Electro zinc plated	2" / DN50	FCS0200
FM/VdS	M10	Electro zinc plated	2-1/2" / DN65	FCS0250
FM/VdS	M10	Electro zinc plated	3" / DN80	FCS0300
FM/VdS	M10	Electro zinc plated	4" / DN100	FCS0400
FM/VdS	M12	Electro zinc plated	5" / DN125	FCS0500
FM/VdS	M12	Electro zinc plated	6" / DN150	FCS0600
FM/VdS	M16	Electro zinc plated	8" / DN200	FCS0800
FM/VdS	M20	Electro zinc plated	10" / DN250	FCS1000



Pipe Hangers & Clamps

Loop hanger | Model SM | FM/VdS



Approval	Size	Finish	Pipe size	Part number
VdS	M8	Electro zinc plated	1/2" / DN15	814326
VdS	M8	Electro zinc plated	3/4" / DN20	814338
VdS	M8	Electro zinc plated	1" / DN25	814340
VdS	M8	Electro zinc plated	1-1/4" / DN32	814351
VdS	M8	Electro zinc plated	1-1/2" / DN40	814363
VdS	M8	Electro zinc plated	2" / DN50	814375
VdS/FM	M10	Electro zinc plated	1/2" / DN15	840684
VdS/FM	M10	Electro zinc plated	3/4" / DN20	899653
VdS/FM	M10	Electro zinc plated	1" / DN25	899665
VdS/FM	M10	Electro zinc plated	1-1/4" / DN32	899677
VdS/FM	M10	Electro zinc plated	1-1/2" / DN40	899689
VdS/FM	M10	Electro zinc plated	2" / DN50	899690
VdS/FM	M10	Electro zinc plated	3" / DN80	841616
VdS/FM	M10	Electro zinc plated	4" / DN100	841628
VdS/FM	M12	Electro zinc plated	5" / DN125	841630
VdS/FM	M12	Electro zinc plated	6" / DN150	841641
VdS/FM	M16	Electro zinc plated	8" / DN200	841653
VdS/FM	M20	Electro zinc Plated	10" / DN250	841665

Clevis hanger | Model 401 | UL/FM



Through hole (mm)	Finish	Pipe size	Part number
12	Electro zinc plated	2-1/2" / DN65	V179424
12	Electro zinc plated	3" / DN80	V179425
16	Electro zinc plated	4" / DN100	V179426
16	Electro zinc plated	5" / DN125	V179427
19	Electro zinc plated	6" / DN150	V179428
22	Electro zinc Plated	8" / DN200	V179429

Pipe clamp with rubber insulation | Model 240



Size	Finish	Pipe size	Part number
M8 / M10	Electro zinc plated	1/4" / DN8	V400078
M8 / M10	Electro zinc plated	3/8" / DN10	V400079
M8 / M10	Electro zinc plated	1" / DN25	V400082
M8 / M10	Electro zinc plated	1-1/4" / DN32	V400083
M8 / M10	Electro zinc plated	44-49 mm	V400084
M8 / M10	Electro zinc plated	1-1/2" / DN40	V400085
M8 / M10	Electro zinc plated	2" / DN50	V400086
M8 / M10	Electro zinc plated	63-67 mm	V400087
M8 / M10	Electro zinc plated	70-73 mm	V400088
M8 / M10	Electro zinc plated	2-1/2" / DN65	V400089
M8 / M10	Electro zinc plated	3" / DN80	V400090
M8 / M10	Electro zinc plated	101-106 mm	V400091
M8 / M10	Electro zinc plated	4" / DN100	V400092
M8 / M10	Electro zinc plated	115-116 mm	V400093
M8 / M10	Electro zinc plated	125 mm	V400094
M8 / M10	Electro zinc plated	136-139 mm	V400096
M8 / M10	Electro zinc plated	140-144 mm	V400097
M8 / M10	Electro zinc plated	5" / DN125	V400098
M8 / M10	Electro zinc plated	6" / DN150	V400099
M8 / M10	Electro zinc plated	210-212 mm	V400101

Pipe Hangers & Clamps

Pipe clamp with rubber insulation | Model 250



Size	Finish	Pipe size	Part number
M8 / M10	Electro zinc plated	1/4" / DN8	V596460
M8 / M10	Electro zinc plated	3/8" / DN10	V596470
M8 / M10	Electro zinc plated	1/2" / DN15	V596480
M8 / M10	Electro zinc plated	3/4" / DN20	V596490
M8 / M10	Electro zinc plated	1" / DN25	V596500
M8 / M10	Electro zinc plated	1-1/4" / DN32	V596510
M8 / M10	Electro zinc plated	44-49 mm	V595859
M8 / M10	Electro zinc plated	1-1/2" / DN40	V595860
M8 / M10	Electro zinc plated	54-58 mm	V595870
M8 / M10	Electro zinc plated	2" / DN50	V595880
M8 / M10	Electro zinc plated	62-64 mm	V595885
M8 / M10	Electro zinc plated	2-1/2" / DN65	V595890
M8 / M10	Electro zinc plated	82-86 mm	V595900
M8 / M10	Electro zinc plated	3" / DN80	V595910
M8 / M10	Electro zinc plated	95-103 mm	V595920
M8 / M10	Electro zinc plated	4" / DN100	V595930
M8 / M10	Electro zinc plated	121-127 mm	V595940
M8 / M10	Electro zinc plated	5" / DN125	V595950
M8 / M10	Electro zinc plated	159-162 mm	V595960
M8 / M10	Electro zinc plated	6" / DN100	V595970
M8 / M10	Electro zinc plated	198-202 mm	V595971
M8 / M10	Electro zinc plated	210-215 mm	V595972
M8 / M10	Electro zinc plated	8" / DN200	V595973

Pipe clamp with rubber insulation | Model HDPCI



Size	Finish	Pipe size	Part number
M8 / M10	Electro zinc plated	3/8" / DN10	V577033
M8 / M10	Electro zinc plated	1/2" / DN15	V577034
M8 / M10	Electro zinc plated	3/4" / DN20	V577035
M8 / M10	Electro zinc plated	1" / DN25	V577037
M8 / M10	Electro zinc plated	1-1/4" / DN32	V577038
M8 / M10	Electro zinc plated	1-1/2" / DN40	V577039
M8 / M10	Electro zinc plated	2" / DN50	V577041
M10 / M12	Electro zinc plated	2-1/2" / DN65	V577043
M10 / M12	Electro zinc plated	3" / DN80	V577045
M10 / M12	Electro zinc plated	4" / DN100	V577048
M12 / M16	Electro zinc plated	5" / DN125	V577052
M12 / M16	Electro zinc plated	6" / DN150	V577055
M16 / M20	Electro zinc plated	8" / DN200	V577061
M16 / M20	Electro zinc plated	10" / DN250	V577066

Pipe clamp without rubber insulation | Model 250

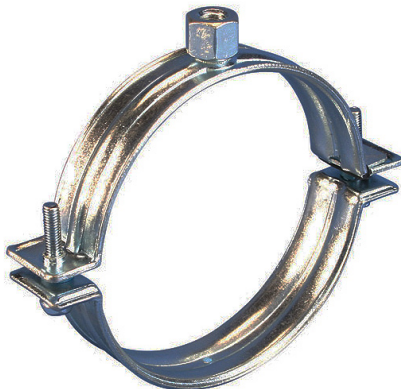

Size	Finish	Pipe size	Part number
M8 / M10	Electro zinc plated	3/8" / DN10	V596210
M8 / M10	Electro zinc plated	1/2" / DN15	V596220
M8 / M10	Electro zinc plated	3/4" / DN20	V596230
M8 / M10	Electro zinc plated	1" / DN25	V596250
M8 / M10	Electro zinc plated	1-1/4" / DN32	V596260
M8 / M10	Electro zinc plated	1-1/2" / DN40	V596270
M8 / M10	Electro zinc plated	2" / DN50	V596280
M8 / M10	Electro zinc plated	62-69 mm	V596290
M8 / M10	Electro zinc plated	67-71 mm	V596300
M8 / M10	Electro zinc plated	2-1/2" / DN65	V596310
M8 / M10	Electro zinc plated	3" / DN80	V596320
M8 / M10	Electro zinc plated	90-98 mm	V596330
M8 / M10	Electro zinc plated	97-107 mm	V596340
M8 / M10	Electro zinc plated	104-110 mm	V596350
M8 / M10	Electro zinc plated	4" / DN100	V596360
M8 / M10	Electro zinc plated	116-126 mm	V596370
M8 / M10	Electro zinc plated	129-140 mm	V596380
M8 / M10	Electro zinc plated	5" / DN125	V596390
M8 / M10	Electro zinc plated	144-154 mm	V596400
M8 / M10	Electro zinc plated	6" / DN150	V596410
M8 / M10	Electro zinc plated	168-176 mm	V596420
M8 / M10	Electro zinc plated	174-184 mm	V596430
M8 / M10	Electro zinc plated	8" / DN200	V596435



Pipe Hangers & Clamps

Pipe clamp without rubber insulation | Model HDPC | FM/VdS



Size	Finish	Pipe size	Part number
M8 / M10	Electro zinc plated	3/8" / DN10	V577003
M8 / M10	Electro zinc plated	1" / DN25	V577004
M8 / M10	Electro zinc plated	1-1/4" / DN32	V577006
M8 / M10	Electro zinc plated	1-1/2" / DN40	V577007
M8 / M10	Electro zinc plated	2" / DN50	V577009
M10 / M12	Electro zinc plated	2-1/2" / DN65	V577011
M10 / M12	Electro zinc plated	3" / DN80	V577013
M10 / M12	Electro zinc plated	4" / DN100	V577016
M12 / M16	Electro zinc plated	5" / DN125	V577020
M12 / M16	Electro zinc plated	6" / DN150	V577023
M12 / M16	Electro zinc plated	8" / DN200	V577028*
M16 / M20	Electro zinc plated	10" / DN250	V577032*

* Not FM approved

Strap pipe clamp | Model OD | Includes screw and nut

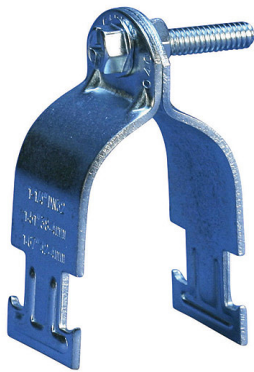

Size (mm)	Finish	Pipe size	Part number
21-23	Electro zinc plated	1/2" / DN15	V598816
26-29	Electro zinc plated	3/4" / DN20	V598818
32-36	Electro zinc plated	1" / DN25	V598822
42-45	Electro zinc plated	1-1/4" / DN32	V712065
46-50	Electro zinc plated	1-1/2" / DN40	V712085
60-63	Electro zinc plated	2" / DN50	V712105
71-74	Electro zinc plated	2-1/2" / DN65	V712115
74-77	Electro zinc plated	2-1/2" / DN65	V712035
86-90	Electro zinc plated	3" / DN80	V712160
112-115	Electro zinc plated	4" / DN100	V712180
138-141	Electro zinc plated	5" / DN125	V712220
139-146	Electro zinc plated	6" / DN150	V712260
167-170	Electro zinc plated	6" / DN150	V712290
218-221	Electro zinc plated	8" / DN200	V712340

Two hole pipe strap



Finish	Pipe size	Hole size (mm)	Thickness (mm)	Part number
Electro galvanised	3/8" / DN10	7	1	V400678
Electro galvanised	1/2" / DN15	7	1	V400679
Electro galvanised	3/4" / DN20	7	1	V400680
Electro galvanised	1" / DN25	7	1	V400681
Electro galvanised	1-1/4" / DN32	7	1	V400682
Electro galvanised	1-1/2" / DN40	7	1	V400683
Electro galvanised	2" / DN50	7	1	V400684

Strap clamp

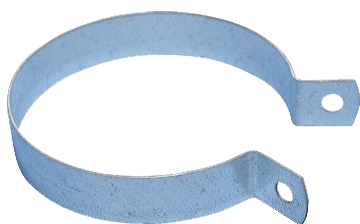

Finish	Pipe size	Hole size (mm)	Thickness (mm)	Part number
Electro galvanised	1/4" / DN8	7	0.6	V574115
Electro galvanised	3/8" / DN10	7	0.6	V574120
Electro galvanised	1/2" / DN15	7	0.6	V574125
Electro galvanised	3/4" / DN20	7	0.6	V574130
Electro galvanised	1" / DN25	7	0.6	V574135
Electro galvanised	1-1/4" / DN32	7	0.9	V574050
Electro galvanised	1-1/2" / DN40	7	0.9	V574060
Electro galvanised	2" / DN50	7	0.9	V574070
Electro galvanised	2-1/2" / DN65	7	1.0	V574080
Electro galvanised	3" / DN80	9	1.0	V574090
Electro galvanised	4" / DN100	9	1.5	V574110

Pipe Hangers & Clamps

Heavy duty riser clamp



Finish	Pipe size	Hole size (mm)	Thickness (mm)	Part number
Hot dipped galvanised	1" / DN25	11	4	V574500
Hot dipped galvanised	1-1/4" / DN32	11	4	V574510
Hot dipped galvanised	1-1/2" / DN40	11	4	V574520
Hot dipped galvanised	2" / DN50	11	4	V574530
Hot dipped galvanised	2-1/2" / DN65	11	4	V574540
Hot dipped galvanised	3" / DN80	11	4	V574550
Hot dipped galvanised	4" / DN100	18	6	V574560
Hot dipped galvanised	5" / DN125	18	6	V574565
Hot dipped galvanised	6" / DN150	18	6	V574570
Hot dipped galvanised	8" / DN200	22	8	V574590

Easy riser clamp



Finish	Pipe size	Hole size (mm)	Part number
Electro galvanised	1/2" / DN15	11	V179325
Electro galvanised	3/4" / DN20	11	V179326
Electro galvanised	1" / DN25	11	V179327
Electro galvanised	1-1/4" / DN32	11	V179328
Electro galvanised	1-1/2" / DN40	11	V179329
Electro galvanised	2" / DN50	11	V179330
Electro galvanised	2-1/2" / DN65	11	V179370
Electro galvanised	3" / DN80	11	V179332
Electro galvanised	4" / DN100	14	V179333
Electro galvanised	5" / DN125	14	V179372
Electro galvanised	6" / DN150	14	V179371
Electro galvanised	8" / DN200	17	V179336
Electro galvanised	10" / DN250	17	V179337

Trapezium hanger | Model TBHK



Type	Approval	Size	Finish	Part number
Drilled	-	10.5 mm	Electro zinc plated	V597581
Threaded	VdS	M8	Electro zinc plated	V597582
Threaded	VdS	M10	Electro zinc plated	V597583
Swivel nut	-	2" / DN50	Electro zinc plated	V597585



Seismic Attachments

Seismic surge restrainer

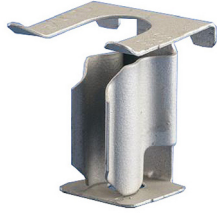





Size	Finish	Part number
1/2" - 2" (DN15 - DN50)	Electro zinc plated	V598298

Seismic attachments for rigid bracing | Electro zinc plated | UL/FM

Product description	Size	Part number
 	-	CSBBARJEG
 	1/2" / DN15	CSBUNIV050EG
	3/4" / DN20	CSBUNIV075EG
 	1/2" / DN15	CSBMA050050EG
	3/4" / DN20	CSBMA050075EG

Seismic Attachments

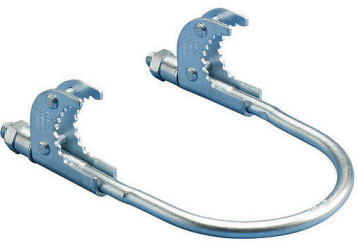
Sway brace attachments | Electro zinc plated | UL/FM

	Product description	Size	Part number		
		Standard universal sway brace	1" / DN25 CSBSTU0100EG 1-1/4" / DN32 CSBSTU0125EG 1-1/2" / DN40 CSBSTU0150EG 2" / DN50 CSBSTU0200EG 2-1/2" / DN65 CSBSTU0250EG 3" / DN80 CSBSTU0300EG 4" / DN100 CSBSTU0400EG 5" / DN125 CSBSTU0500EG 6" / DN150 CSBSTU0600EG 8" / DN200 CSBSTU0800EG 10" / DN250 CSBSTU1000EG		
			Quick grip lateral sway brace	2-1/2" / DN65 CSBQG0250EG 3" / DN80 CSBQG0300EG 4" / DN100 CSBQG0400EG 5" / DN125 CSBQG0500EG 6" / DN150 CSBQG0600EG 8" / DN200 CSBQG0800EG	
				Quick grip jr. lateral sway brace	1" / DN25 CSBQIKCL0100EG 1-1/4" / DN32 CSBQIKCL0125EG 1-1/2" / DN40 CSBQIKCL0150EG 2" / DN50 CSBQIKCL0200EG



Seismic Attachments

Branch line restraint system | Electro zinc plated | UL/FM

Product description		Size	Part number
		1" / DN25	CSBBRP0100EG
		1-1/4" / DN32	CSBBRP0125EG
		1-1/2" / DN40	CSBBRP0150EG
		2" / DN50	CSBBRP0200EG
		M10/M12	CSBBRS1MEG
		M10/M12	CSBBRS2MEG
		M10/M12	CSBBRS3MEG
		M10/M12/M16	CSBRS1

* without approval



Channels & Cantilevers

Strut channel | Galvanised

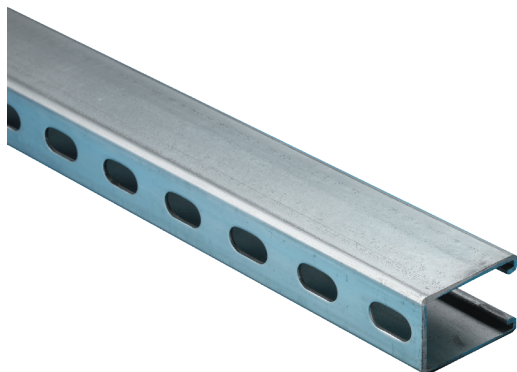

Length (m)	Height (mm)	Width (mm)	Thickness (mm)	Part number
3	41	41	2.5	STRUT41FM
6	41	41	2.5	STRUT41FM6
3	41	41	2	STRUT41FMH
6	41	41	2	STRUT41FMH6
3	21	41	2.5	STRUT21FMH
6	21	41	2.5	STRUT21FMH6
3	21	41	2	STRUT21FM
6	21	41	2	STRUT21FM6
3	40	38	2	STRUT38FM
6	40	38	2	STRUT38FM6
3	20	32	2.5	STRUT32FM
6	20	32	2.5	STRUT32FM6

Scandic channel | Electro zinc plated

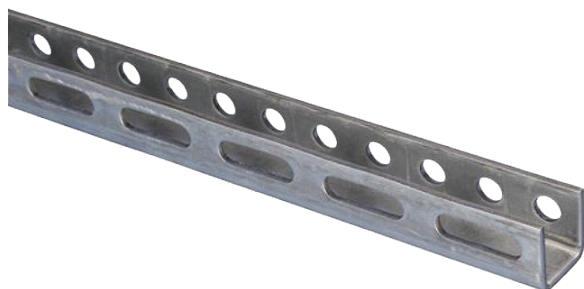

Length (m)	Height (mm)	Width (mm)	Thickness (mm)	Part number
2	30	30	2	V312200
3	30	30	3	V312230

Cantilever strut | Hot dipped galvanised



Length (mm)	Height (mm)	Width (mm)	Part number
150	41	41	591-18
200	41	41	591-2
250	41	41	591-17
300	41	41	591-4
400	41	41	591-16
500	41	41	591-15
600	41	41	591-9
100	21	41	591-6
200	21	41	591-1
300	21	41	591-3
300	82	41	591-5
400	82	41	591-7
500	82	41	591-8
600	82	41	591-10
700	82	41	591-14
800	82	41	591-13
900	82	41	591-11
1000	82	41	591-12



Channels & Cantilevers

Cantilever - scandic | Galvanised

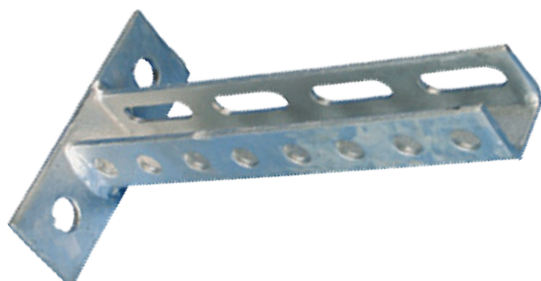



Length (mm)	Height (mm)	Width (mm)	Part number
150	30	30	V312040
200	30	30	V312060
250	30	30	V312020
300	30	30	V312030
400	30	30	V312050
500	30	30	V312070
600	30	30	V312080

Supported cantilever - scandic | galvanised



Length (mm)	Height (mm)	Width (mm)	Part number
250	30	30	V312110
300	30	30	V312120
400	30	30	V312140
500	30	30	V312160
600	30	30	V312170
800	30	30	V312180
1,000	30	30	V312190

Strut accessories

Product description	Material	Part number	Product description	Material	Part number
 Base plate 4141	Galvanised	V313822	 Base plate 4182	Galvanised	V313823
 End cap 4141	Plastic	V313305			

Nuts & Bolts

U-bolt kits | Including 4 nuts

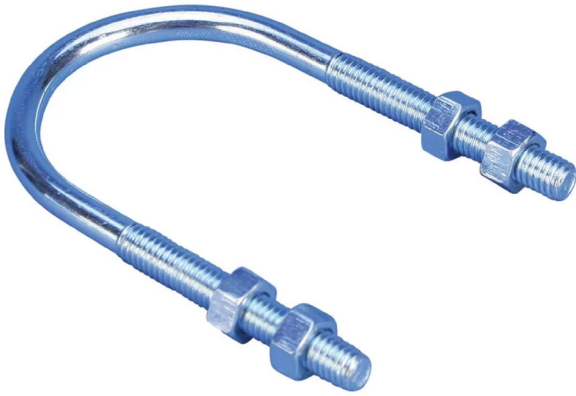

Pipe size	Finish	Bolt size	Part number
3/8" / DN10	Electro galvanized	M6	UB4N017M6
1/2" / DN15	Electro galvanized	M6	UB4N021M6
3/4" / DN20	Electro galvanized	M8	UB4N027M8
1" / DN25	Electro galvanized	M8	UB4N034M8
1-1/4" / DN32	Electro galvanized	M8	UB4N042M8
1-1/2" / DN23	Electro galvanized	M8	UB4N049M8
2" / DN50	Electro galvanized	M8	UB4N060M8
2-1/2" / DN65	Electro galvanized	M8	UB4N076M8
3" / DN80	Electro galvanized	M8	UB4N090M8
3" / DN80	Electro galvanized	M10	UB4N090M10
4" / DN100	Electro galvanized	M10	UB4N114M10
5" / DN125	Electro galvanized	M8	UB4N140M8
6" / DN150	Electro galvanized	M14	UB4N168M14
8" / DN200	Electro galvanized	M10	UB4N219M10
8" / DN200	Electro galvanized	M16	UB4N219M16
10" / DN250	Electro galvanized	M16	UB4N273M16
12" / DN300	Electro galvanized	M10	UB4N323M10



Nuts & Bolts

Hex nuts



Bolt size	Part number
M6	N06
M8	N08
M10	N10
M12	N12
M16	N16
M20	N20

Serrated flange nuts



Bolt size	Part number
M10	BOL009M10FN
M12	BOL009M12FN

Bolts



Bolt size	Length (mm)	Part number
M8	25	M6S08025B
M8	30	M6S08030B
M8	35	M6S08035B
M8	40	M6S08040B
M10	30	M6S10030B
M10	40	M6S10040B
M10	50	M6S10050B
M12	40	M6S12040B
M16	60	M6S16060B

Washers



Bolt size	Diameter (mm)	Thickness (mm)	Part number
M6	12	1.6	W06
M8	16	1.6	W08
M8	28	3	V584596
M8	35	3	V584598
M8	40	3	V584600
M10	20	2	W10
M10	28	3	V584597
M10	35	3	V584599
M10	40	3	V584610
M12	24	2.5	W12
M12	40	3	V584611
M16	30	3	W16
M16	40	3	V584612
M20	36	3	W20

Nuts & Bolts

Beam clamps

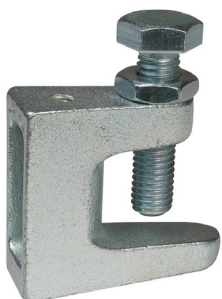

Bolt size	Type	Approval	Part number
M8	Threaded	VdS	TKN08
M10	Threaded	FM/VdS	TKN10
M12	Threaded	FM/VdS	TK12
M8	Unthreaded	VdS	TKN09
M10	Unthreaded	FM/VdS	TKN11
M12	Unthreaded	FM/VdS	TK13
Retaining strap	M8/10/12	-	V590240

Coach screws



Size	Length (mm)	Part number
M10	50	BOL009M10050CS
M10	65	BOL009M10065CS
M10	100	BOL009M10100CS

Channel nuts | For strut channels

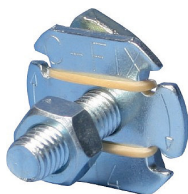

Bolt size	Finish	Spring	Part number
M8	Electro galvanised	No	V315015
M10	Electro galvanised	No	V315025
M12	Electro galvanised	No	V315035
M8	Electro galvanised	Yes	V315095
M10	Electro galvanised	Yes	V315105
M12	Electro galvanised	Yes	V315115

Threaded rod

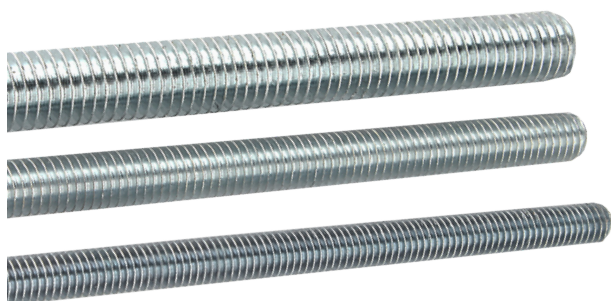

Type	Bolt size	Finish	Length (m)	Part number
DIN 976	M6	Galvanised	1	V592570
DIN 976	M6	Galvanised	2	V592580
DIN 976	M8	Galvanised	1	V592590
DIN 976	M8	Galvanised	2	V592600
DIN 976	M10	Galvanised	1	V592610
DIN 976	M10	Galvanised	2	V592620
DIN 976	M12	Galvanised	1	V592630
DIN 976	M12	Galvanised	2	V592640
DIN 976	M6	Galvanised	3	V592650
DIN 976	M8	Galvanised	3	V592660
DIN 976	M10	Galvanised	3	V592670
DIN 976	M12	Galvanised	3	V592680



Nuts & Bolts

Rod connectors & reducer couplings



Type	Model	Bolt size	Finish	Part number
Angled	FSO	M10	Galvanised	V598290
Straight	FSO	M10	Galvanised	V598300
Straight	FSO	M16	Galvanised	V598310
Round	EM	M8	Electro zinc plated	V592310
Round	EM	M10	Electro zinc plated	V592320
Round	EM	M12	Electro zinc plated	V952330
Round	EM	M16	Electro zinc plated	V592331
Hexagonal	EM HEX	M8	Electro zinc plated	V592340
Hexagonal	EM HEX	M10	Electro zinc plated	V592350
Hexagonal	EM HEX	M12	Electro zinc plated	V952335
Hexagonal	EM HEX	M16	Electro zinc plated	V592336
Reducer	-	M10-M8	Electro zinc plated	V583870
Reducer	-	M12-M8	Electro zinc plated	V583880
Reducer	-	M12-M10	Electro zinc plated	V583890

Anchor | Model CA



Model	Size	Finish	Length (mm)	Approval	Part number
CA anchor	M8	Zinc chromate	30	VdS	V593190
CA anchor	M10	Zinc chromate	40	FM/VdS	V593200
CA anchor	M12	Zinc chromate	50	FM/VdS	V400415
CA anchor	M16	Zinc chromate	65	FM/VdS	V400416
CA install tool	M8	-	-	-	V593160
CA install tool	M10	-	-	-	V593170
CA install tool	M12	-	-	-	V400420
CA install tool	M16	-	-	-	V400421

Expansion bolt | Model SAB



Size	Finish	Length (mm)	Approval	Part number
M8	Electro zinc plated	75	VdS	V400408
M8	Electro zinc plated	115	VdS	V400409
M10	Electro zinc plated	90	FM/VdS	V400410
M10	Electro zinc plated	130	FM/VdS	V400411
M12	Electro zinc plated	145	-	V401158
M12	Electro zinc plated	180	-	V401159

Expansion anchor | Model CL

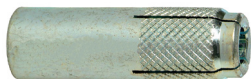

Size	Finish	Part number
M8	Brass	V593100
M10	Brass	V593110

Nuts & Bolts

Toggle anchor | Model MTVB

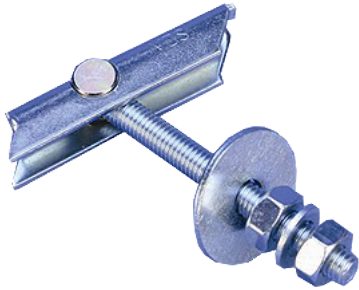

Size	Finish	Length (mm)	Approval	Part number
M8	Electro zinc plated	100	VdS	V584455
M8	Electro zinc plated	200	VdS	V584456
M8	Electro zinc plated	300	VdS	V584457
M8	Electro zinc plated	500	VdS	V584458
M10	Electro zinc plated	100	FM/VdS	V584465
M10	Electro zinc plated	200	FM/VdS	V584466

Baseplate | Model PBF



Size	Finish	Holes	Part number
M8/M10	Electro zinc plated	2 x 9 mm	V587145
1/2" / DN15	Electro zinc plated	2 x 9 mm	V587125

Slide set for strut channel 4141



Size	Finish	Part number
M10/M16	Electro galvanised	P126755





Europe, Middle East & Africa

BENELUX

Viking SupplyNet bv
Eekboerstraat 28b-3
NL-7575 AX Oldenzaal
Netherlands
Tel.: +31 (0)541 573233
vikingnetherlands@viking-emea.com

CENTRAL & EASTERN EUROPE

Viking GmbH
Industriestr. 10/12
D-23840 Bad Oldesloe
Germany
Tel.: +49 (0)4531 803 8087
vikinggermany@viking-emea.com

FRANCE

Sprinkler Viking France S.à r.l.
Centre d'Affaires CESCO
4, rue Marconi
BP 25180
F-57075 Metz Cedex 03
France
Tel.: +33 (0)800 10 29 23
vikingfrance@viking-emea.com

IBÉRICA

Viking Sprinkler S.A.
Calle Picos de Europa 4A
San Fernando de Henares
E-28830 Madrid
Spain
Tel.: +34 91 677 8352
vikingiberica@viking-emea.com

ITALY

Viking Italia S.r.l.
Via Pavia, 76
I-27042 Bressana Bottarone (PV)
Italy
Tel.: +39-(0)2- 30550778
vikingitaly@viking-emea.com

MIDDLE EAST

Viking Arabia FZE
LOB 19 Office #2007
Post Box No. 17531
Jebel Ali Free Zone, Dubai
United Arab Emirates
Tel.: +971 (0)4 8895 561
vikingdubai@viking-emea.com

NORDIC

Viking Nordic AB
Staffans Väg 5
S-192 78 Sollentuna
Sweden
Tel.: +46 (0)8 594 415 90
vikingsweden@viking-emea.com

POLAND

Viking SupplyNet Sp. z o.o.
ul. Żelazna 59
PL-00 848 Warsaw
Poland
Tel.: +48 22 103 30 54
vikingpoland@viking-emea.com

ROMANIA & BULGARIA

Viking Romania S.r.l.
Strada Vulturilor 18-18A, cam 3
The LOBBY
RO-030855 Bucharest
Romania
Tel.: +40 21 311 51 48
vikingromania@viking-emea.com

TURKEY

Viking Turkey Yangın Korunum Sistemleri Ticaret A.Ş.
Sahrayıcedit Mah. Halk Sokak
Golden Plaza C Blok No:29, Kat:4, Daire:8
Sahrayı Cedit, Kadıköy - 34734 İstanbul
Turkey
Tel.: +90 (0)216 403 18 00
vikingturkey@viking-emea.com

UK & IRELAND

Viking SupplyNet Ltd.
Unit 2 - Byram House, Newborn Court
Chapel Street
Epworth DN9 1HQ
United Kingdom
Tel.: +44 (0)1427 871 000
vikinguk@viking-emea.com

For further information,
please visit
www.viking-emea.com



For further information, please contact your local Viking sales office or refer to the technical documentation.
The contents of this publication are subject to modifications without notice.

Photo
Cover: © Viking/Minimax

Trusted above all.

Viking S.A. | Z.I. Haneboesch, L-4562 Differdange / Niederkorn, Luxembourg | Tel.: +352 58 37 37 - 1, vikinglux@viking-emea.com

